

ATTENZIONE AL PESCE D'APRILE!!!

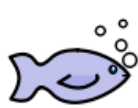

PREPARA TANTI PESCIOLINI (QUI TROVI LE ISTRUZIONI PER

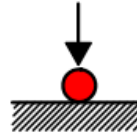
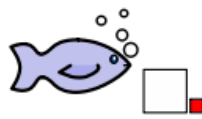

ALCUNI ORIGAMI O DISEGNI DA COLORARE) E DIVERTITI AD



ATTACCARLI SULLA SCHIENA DEI TUOI FAMILIARI SENZA

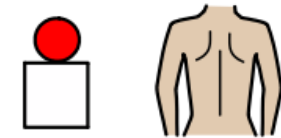
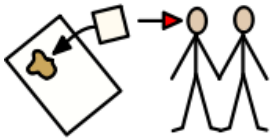

FARTI SCOPRIRE!!!

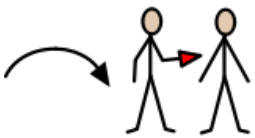

BUON DIVERTIMENTO!!!



★

Quando piove non mi bagno
Tira vento non mi lagno.
Sempre fresco e in allegria
Passerò la vita mia?
Vita fatta per la quiete
E non già per una rete.
Il pesce

pesce

modello tradizionale

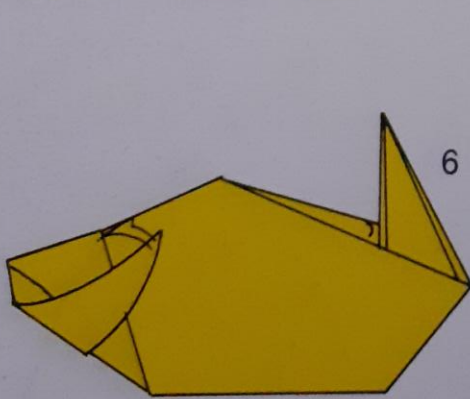
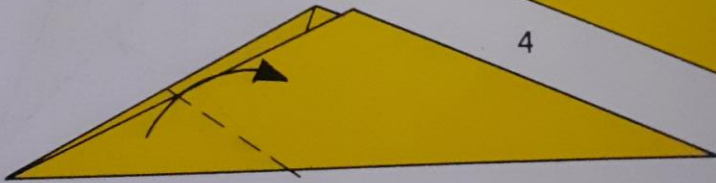
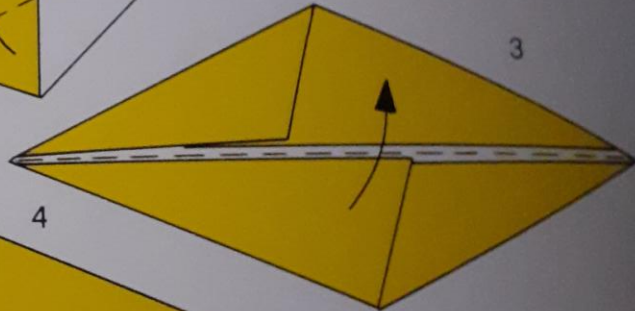
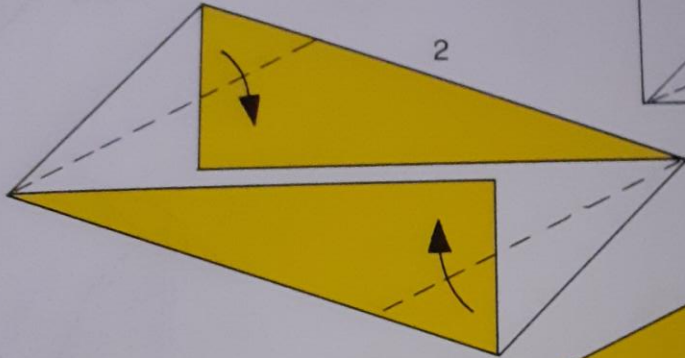
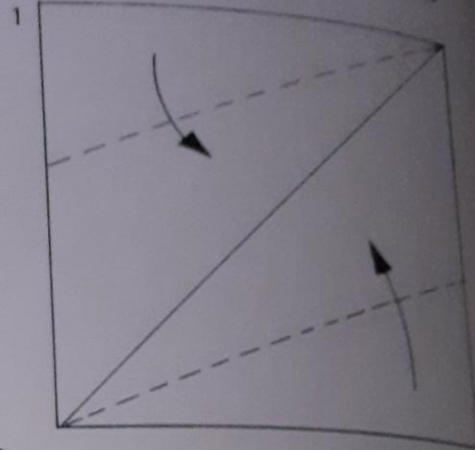

inserisci la punta

arrotola

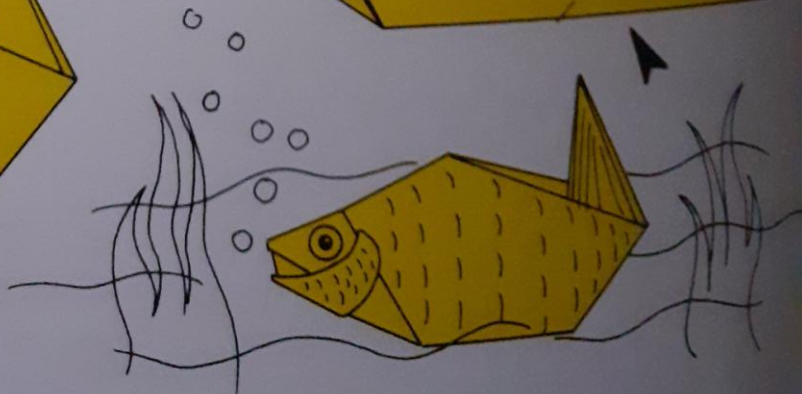
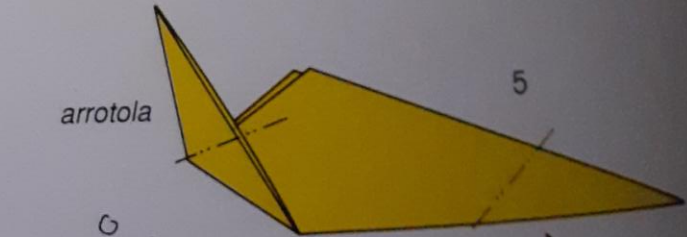

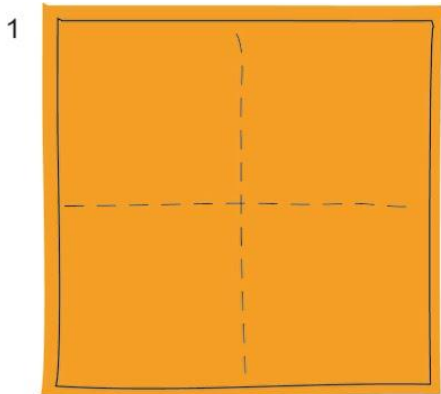

piegare le mediane a valle

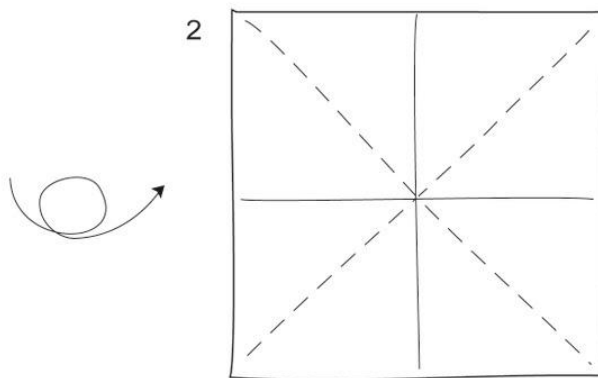

girare e piegare le diagonali a valle

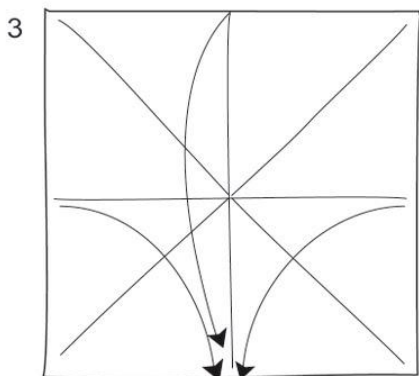

eseguire le tre pieghe a valle

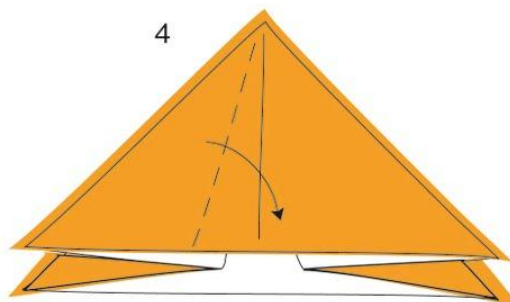

piegare l'angolo oltrepassando la metà

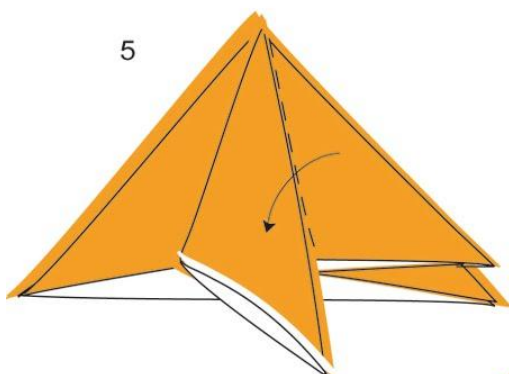

ripetere con l'altro angolo

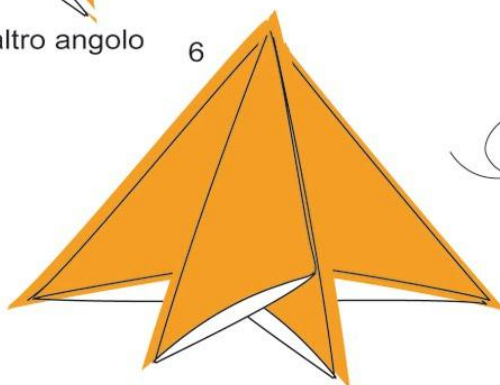

girare e colorare a piacere

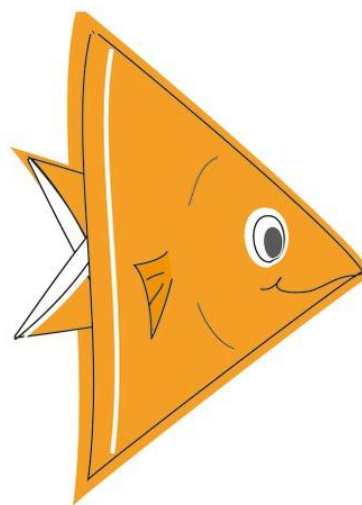

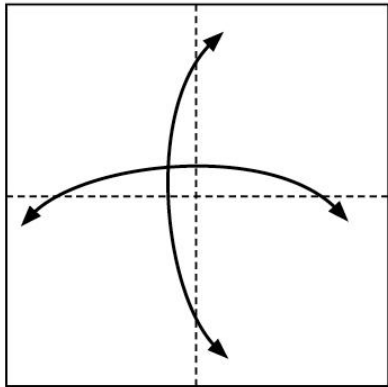

1 piegare a metà due volte e ripiegare

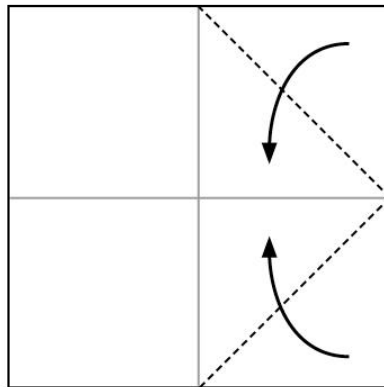

2 piega lungo la linea tratteggiata e gira il foglio

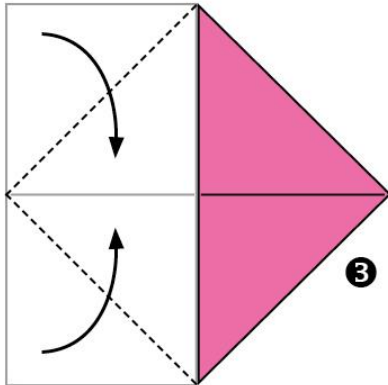

3 piega lungo le linee tratteggiate e gira il foglio

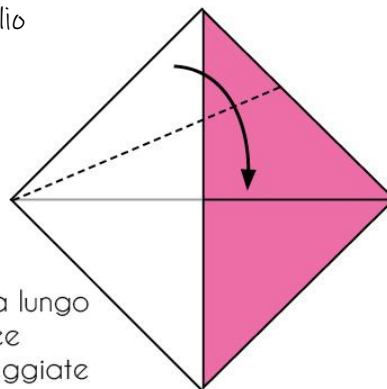

4 piega lungo le linee tratteggiate

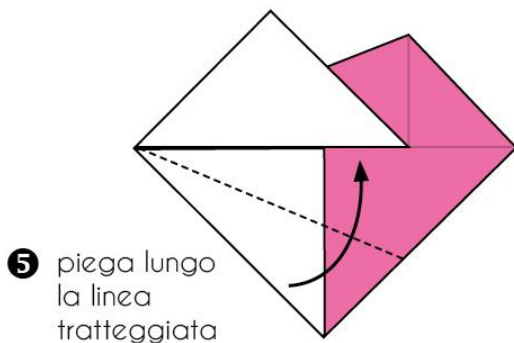

5 piega lungo la linea tratteggiata

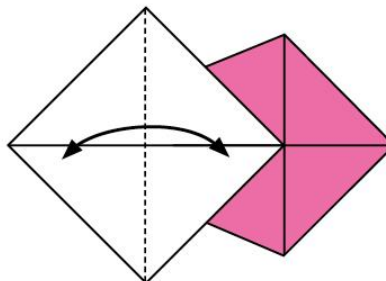

6 piega in mezzo

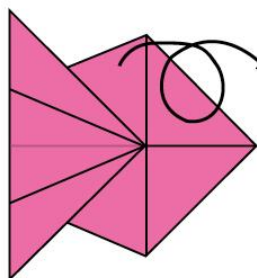

7 gira

8 disegna una faccia e hai finito

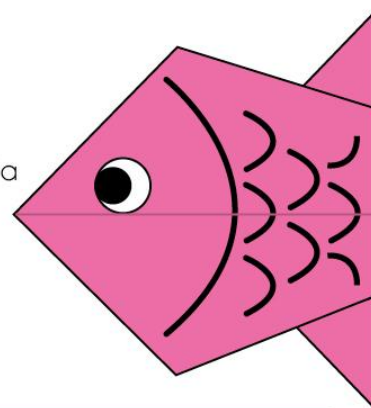

IL PESCE

